

POWERSTAR Road Sweeper Body Kit

User's Manual



POWERSTAR TRUCKS INDUSTRY CO., LIMITED

<http://www.isuzutruckscn.com/>

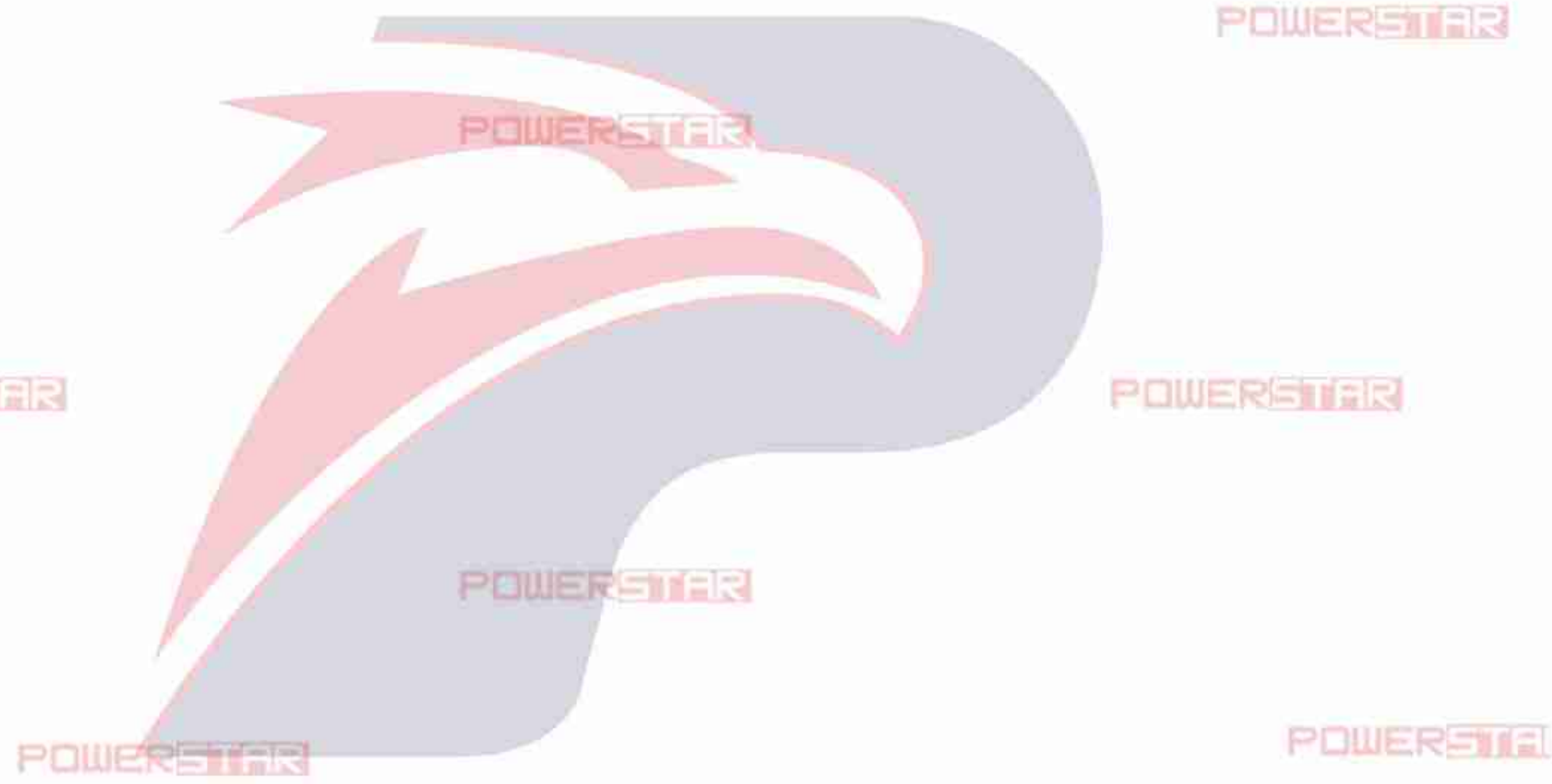

POWERSTAR Road Sweeper Kit



OWNER'S MANUAL

POWERSTAR

Preface

Thank you for purchasing PowerStar products. For better using your Road Sweeper superstructure, get the best operating performance, we strongly suggest that before the operation process you should read this manual instructions carefully, and to manipulate the program handily.

The manual detailed describes the performance of road sweeper kit, structure, usage, precautions and maintenance of such knowledge. While showing details of the road sweeper up-body, both pictures and description will together help you get better understanding of how to use it. Before the operation, the skilled operator should carefully read the contents of the manual.

After master the kit performance characteristics, methods of operation and precautions, then could start to operate this street sweeper. In order to ensure the staff turnover after the operation, and properly use of the assembling truck. This manual book must be properly kept, shall not be lost and damage.



---POWERSTAR TRUCKS

Contents

Chapter 1. General Description	5
Chapter 2, Main Technical Data.....	6
i ,Road Sweeper Superstructure technical parameter	6
ii ,Road Sweeper Superstructure advanced features	7
Chapter 3, Road Sweeper Truck Structure Components	8
i ,Road Sweeper Truck Structure Components	8
Chapter 6, Road Sweeper Superstructure Working Principles.....	13
i ,How are the sweeper up-body working?	13
ii ,What is the main component for truck?	13
iii, How to operate fuel tanker trucks?. (Very Important).....	14
Chapter 7, Troubleshooting	20
Chapter 7, Others for Attention	21
i ,Precautions for Use.....	21
ii ,Maintenance.....	22

POWERSTAR

Chapter 1. General Description

POWERSTAR Road Sweeper Superstructure based on customer supply truck chassis CAD drawing, capacity for Dust tank can be up to 4000Liters and capacity for Water tank can be up to 1000Liters, which also installed with best performed Japanese technology brand ISUZU diesel auxiliary engine. Sweeping Device installed at middle of truck with 4 brushes for cleaner sweeping working; Vacuum Suction Device installed rear of truck for dust suction and avoid second pollution. The Auxiliary engine and Fan use centrifugal auto clutch connection, which can ensure auxiliary engine no-loading starting. The sweeping device can be retract automatically when blocked, which efficiently protect the device from damage.

The vehicle designed to fully rely on the advantages of the original of ISUZU brand LHD chassis. The road sweeper has advantage of sweeping widely and suction efficiently, and maintenance for whole truck can be easily. The tank material is international standard stainless steel, which can effective to avoid rusting. Arrow light installed at rear of tank to make sure working safety.

The Road Sweeper Kit sweeping speed faster and can efficiently avoid raising dust. And widely used for city road, high-way, airport road, seaport road, bridge, square, community, factory, etc. Therefore, the vehicle is an ideal Road Sweeper Truck mainly for road cleaning.



(Preview for your Road Sweeper Superstructure)

Chapter 2, Main Technical Data

ii ,Road Sweeper Superstructure technical parameter

Items		Parameter
Water Tanker	Capacity (Liters)	4000
	Material	Stainless Steel
Dust Tanker	Capacity (Liters)	1000
	Material	Stainless Steel
Auxiliary Engine	Model	ISUZU technology engine
	Specifications	Four stroke, water cooled, diesel engine
	Power	57KW
Sweeping System Parameter	Brush Plate	Four brush plate, totally 88 units sweeping brush, with 800mm sweeping dimension
	Maximum sweeping width	3200 mm
	Sweeping speed	3~25 km/h
	Maximum sweeping ability	9600-80000 m ² /h

Note:1. Superstructure design & produce totally based on customer supply chassis CAD drawing

2. We keep the right to revise the parameters on the list above.

POWERSTAR

ii ,Road Sweeper Superstructure advanced features

This vehicle is a wet road sweeping vehicle retrofitted by adding a top mounted dedicated sweeping device powered by ISUZU technology auxiliary engine to the customer supply ISUZU mini chassis. This road sweeper up-body has a simple and proper structure with four brushes in the middle and a suction port at the back part of the kit. The efficient suction system makes low noises when the vehicle is working. The whole vehicle is stable in performance.

- 1. At the back part of this street cleaning kit there is an indicating arrow to make sure the road sweeper truck can work safely.*
- 2. With individual controls for the water sprayed through the brush disks or the suction pipe, this vehicle is easy to operate.*
- 3. High quality automatic centrifugal clutch is adopted in this product to start the auxiliary engine without load. The clutch is in a semi-open structure which makes it easy to check to what degree the wear plate is worn. Just unscrewing one gland bolt you can take out the core of the clutch to replace the wear plate.*
- 4. The hydraulic valve group of our road sweeper kit is composed of thread cartridge valves introduced from the American HF (Hydra Force) company. The thread cartridge valves feature compact structure, light weight, powerful functions, high reliability and easy maintenance. They are popular hydraulic valves for vehicles in Europe and America. The hydraulic valve group contains an electric-hydraulic proportional speed regulating valve to control the revolving speed of the sweeping brushes. The operator can achieve stepless regulation to the revolving speed of the sweeping brushes by adjusting the electronic control rotary knob. Besides, customers can also choose to install the sandwich valve group produced by Japanese Yuken according to the practical need.*
- 5. The driving motors of the sweeping brushes and the brush disks are high-quality cycloidal motors which have high transmission efficiency and long service life.*
- 6. The electronic control system of this road sweeper truck is controlled by single chip microcomputer. The highly centralized control box is quite intelligent with low failure rate and only a few control switches. With such an electronic control system, the operator can control all the operations of the vehicle in the cab.*
- 7. When dumping garbage, the garbage bin can incline 60° at most. Since the water tank is mounted under the garbage bin, the bottom board of the garbage bin has already inclined 12° from the vehicle body. This makes the garbage dumping more easily and thoroughly.*
- 8. Various sorts of optional equipment are available. Customers can decide to install rolling brushes to the suction port. Rear mounted dirty water suction pipe or snow plow can be added to this road sweeper truck to make it multifunctional.*

Chapter 3, Road Sweeper Truck Structure Components

i ,Road Sweeper Truck Structure Components

Overview for Road Sweeper truck structure technical drawing:

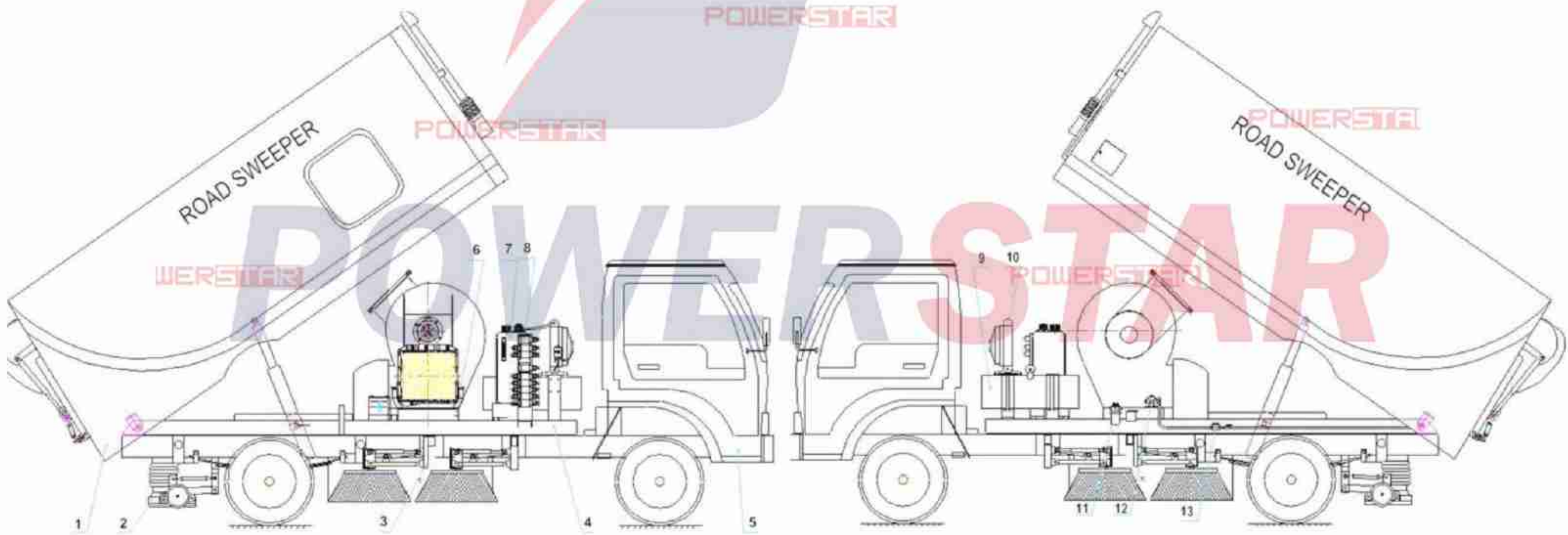

- | | |
|--------------------------------|---|
| 1. Dust Tank Assembly | 2. Dust Vacuum Suction Device |
| 3. 4 units brushes Assembly | 4. ISUZU Tech Auxiliary Engine Assembly |
| 5. FOTON chassis | 6. Power Assembly |
| 7. Hydraulic Oil Tank Assembly | 8. Hydraulic Pipeline and Valve |
| 9. Diesel Fuel tank | 10. Radiator Assembly |
| 11. Auxiliary Engine Oil Pump | 12. Water Spray Pump |
| 13. Solenoid Valve | |

Above drawing show detailed parts for this road sweeper superstructure, which based on customer supply FOTON type 2 chassis, with white painting and blue, red decoration, single row cabin, wheelbase as required, detailed picture for chassis drawing as below:

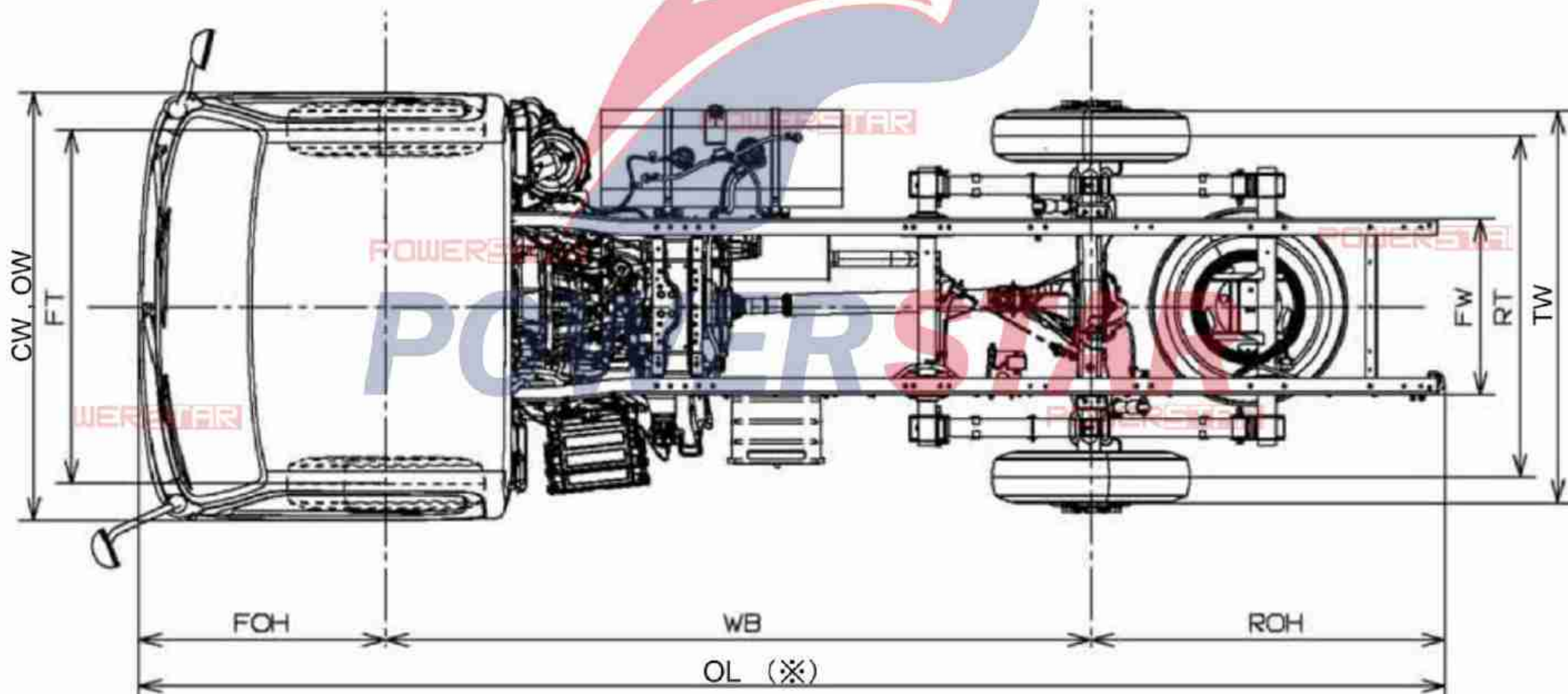

Sweeping Brush Assembly: Totally four sets. Water spraying nozzle above the brushes



Left Side View
(Driver's Side)
2 brushes

Right Side View
2 brushes

Water Spraying
Nozzles

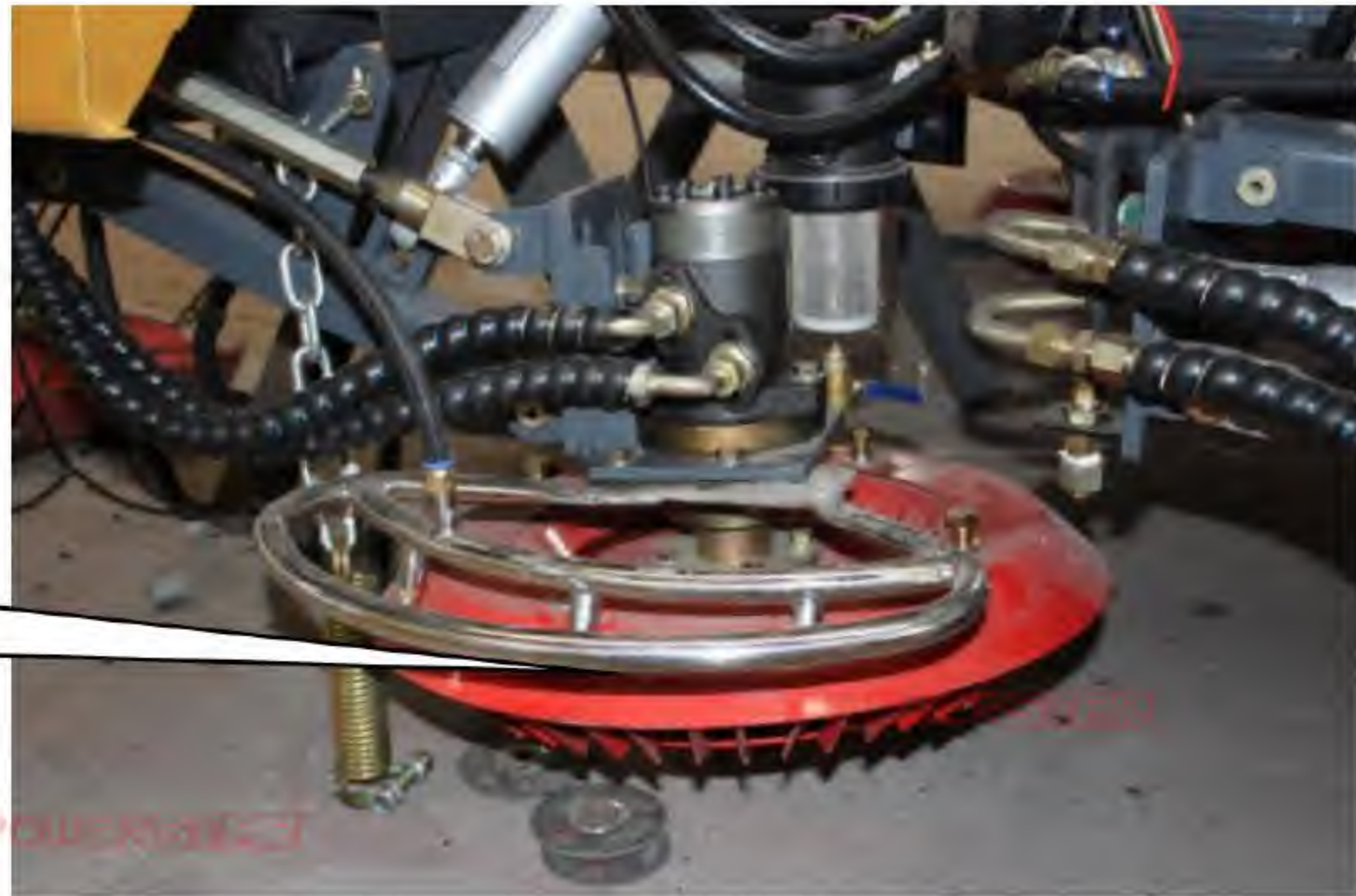

Left Side view of the Truck: equipped with Powerful fan, imported PLC modules, both chassis engine and auxiliary use same fuel tank.



Powerful Fan

Fuel Tank installation
place (Both Chassis
engine & JMC Auxiliary
engine use same tank)

Right Side view of the Truck: equipped with Radiator and Hydraulic Oil Tank. Water Inlet Valve

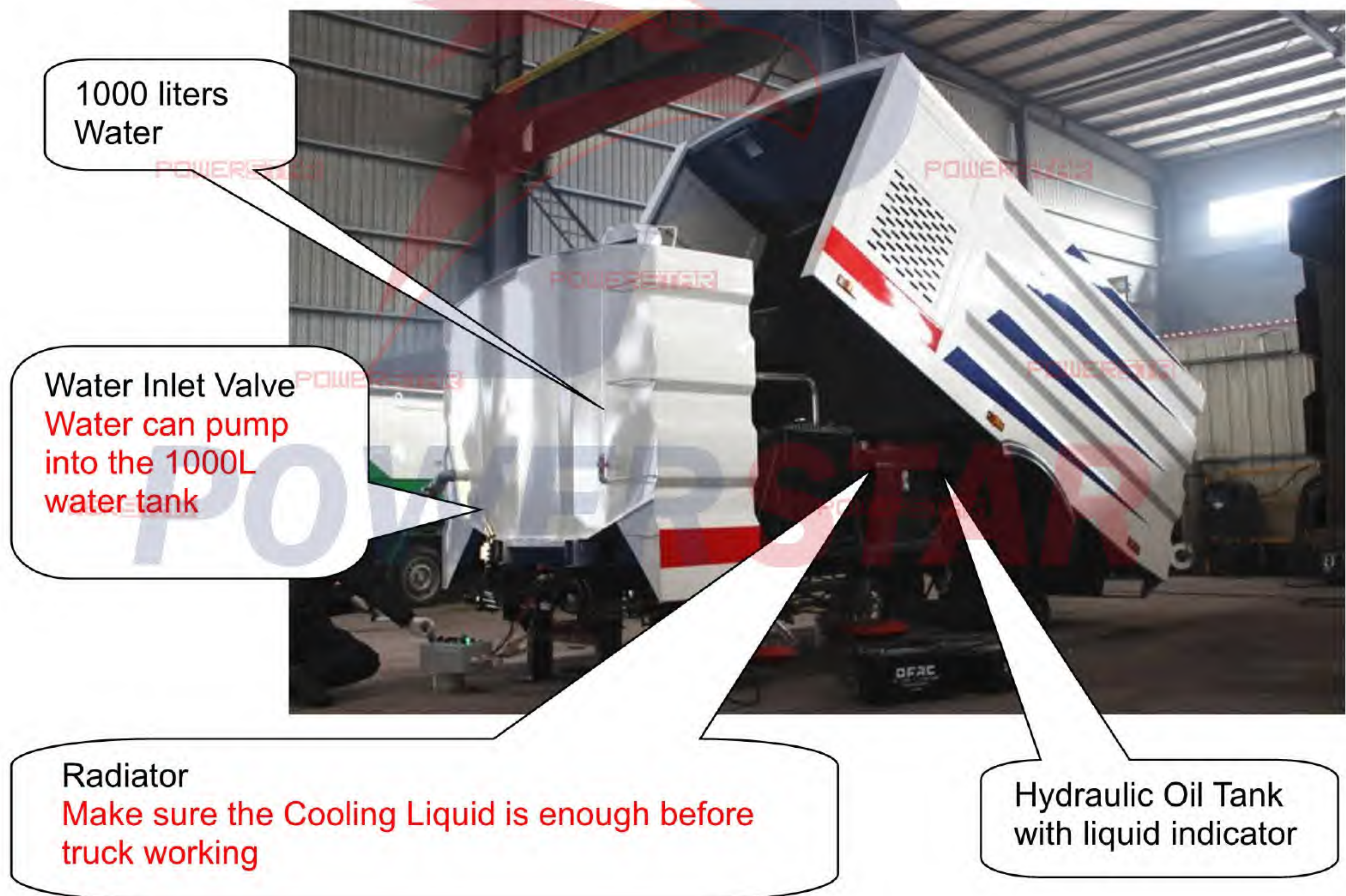

Middle view of the Truck: equipped with ISUZU technology auxiliary engine 57kw.





When lifting the tank, make sure the **Red Safety Support** in right position

Rear view of the Truck: equipped with ISUZU technology auxiliary engine.

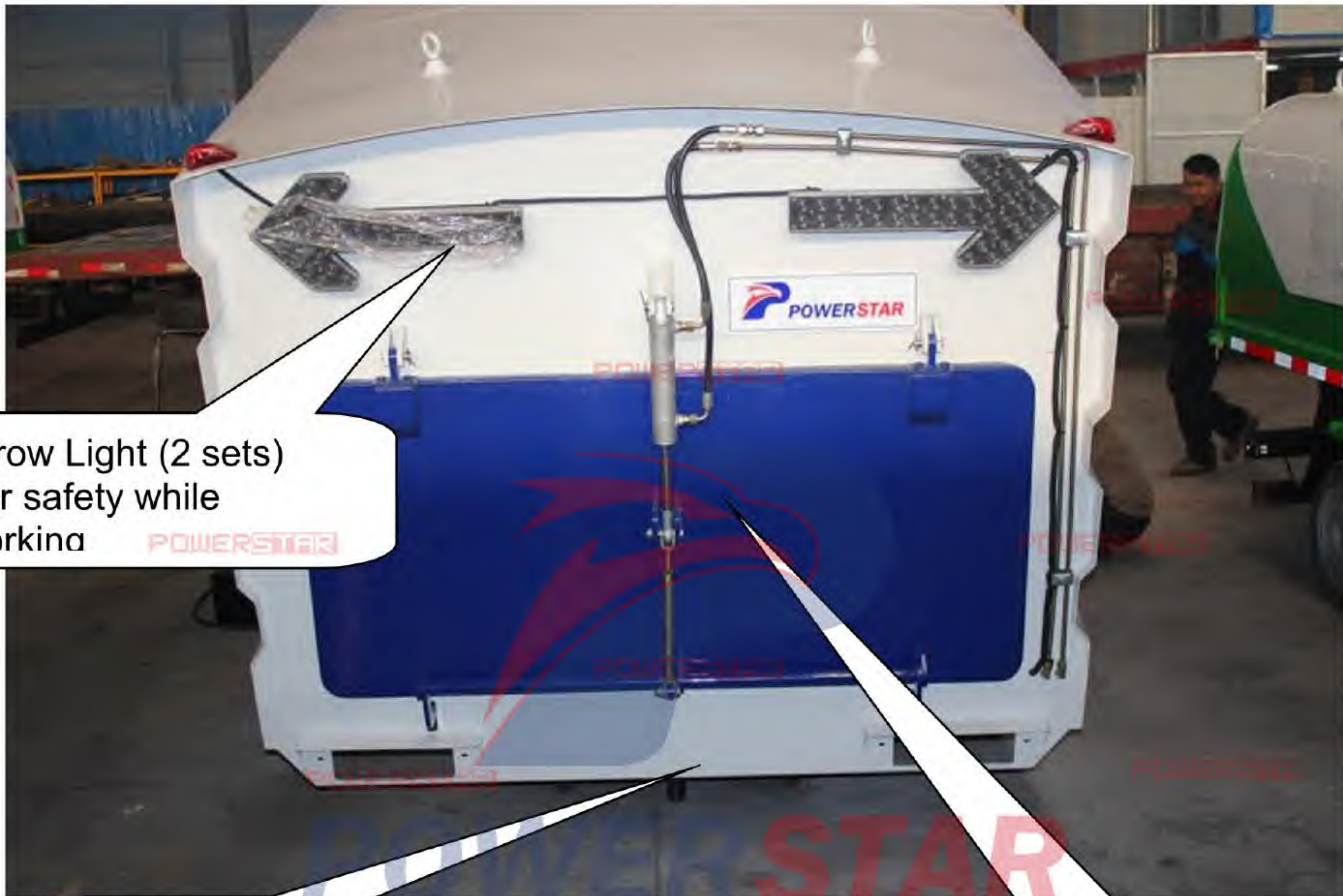

Arrow Light (2 sets)
For safety while
working

Dust Vacuum
Suction Device

Hydraulic Rear Door
For discharging dust

Control System of the road sweeper truck: control box in Cabin



Main Control Box function introduction:

1. Control the whole Sweeping operation
2. English Version Panel for guidance
3. Control the whole body up & down
4. Control the rear door open & close

Top of the road sweeper truck: on top of the body with one Air-vent.



On top of the road sweeper truck body installed one Air-Vent

Chapter 6, Road Sweeper Superstructure Working Principles

The operator should fully understand Whole Structure and Working Principle for Road Sweeper Superstructure before any operation. Only trained person can operate this vehicle properly and to prevent unnecessary accidents and equipment damage.

i ,How are the sweeper up-body working?

The Road Sweeper Superstructure makes use of the ISUZU technology auxiliary engine to get the power, and the engine drive the sweeping system, fans and vacuum suction plate working. Operation the main control box inside the cabin, and adjust the truck speed to sweeping faster and slowly. After sweeping working, cleaning the dust tank, add enough water into water tank, and ready for next time operation.

ii ,What is the main component for truck?

The road sweeper truck kit is design & produce based on customer supply chassis drawing. The refit part includes road sweeping assembly, actuator device and operation system.

- Road sweeping assembly: One stainless steel dust tank & one stainless steel water tank. 4 units brush plate & 88 units brushes, vacuum suction plate and water spraying system.
- Actuator device: includes Isuzu technology auxiliary engine, drive line, etc., which can pass the power to the pump.
- Operation system: helps come to all special functions' convert.

iii, How to operate fuel tanker trucks?. (Very Important)

Main control box in cabin (English version plate):



1. ISUZU Technology Auxiliary Engine **Revolving Speed** panel: Recommended working Revolving Speed is 1800r/min~2000r/min, which based on road condition



2. Button #9 (L.front sweep) control **Front Brush** for left side:
Operation: Turn Up, the LEFT SIDE Front Brush move **outside**;
Turn Down, the LEFT SIDE Front Brush move **inside**.

3. Button #10 (R.front sweep) control **Front Brush** for right side:
Operation: Turn Up, the RIGHT SIDE Front Brush move **outside**;
Turn Down, the RIGHT SIDE Front Brush move **inside**.

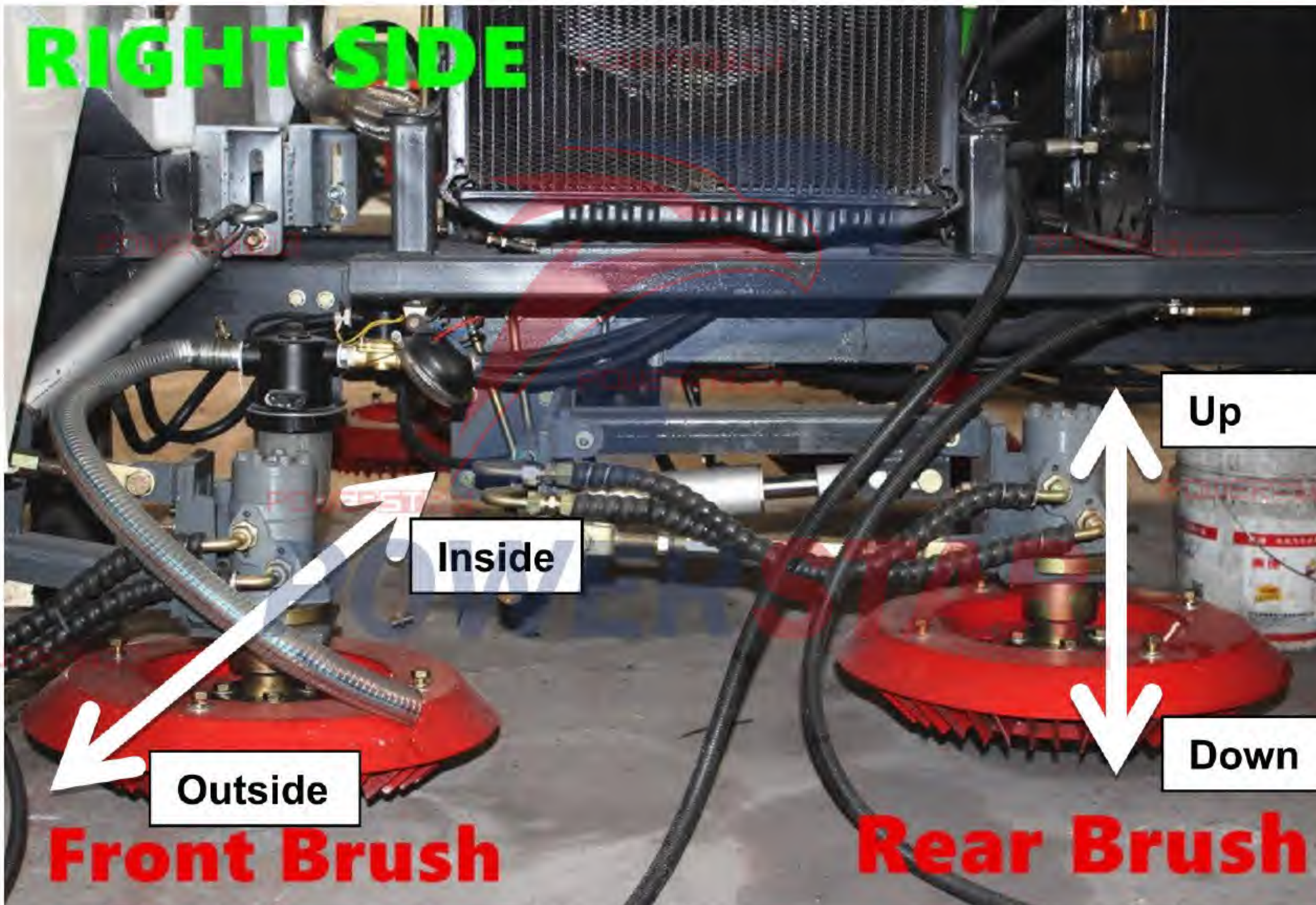
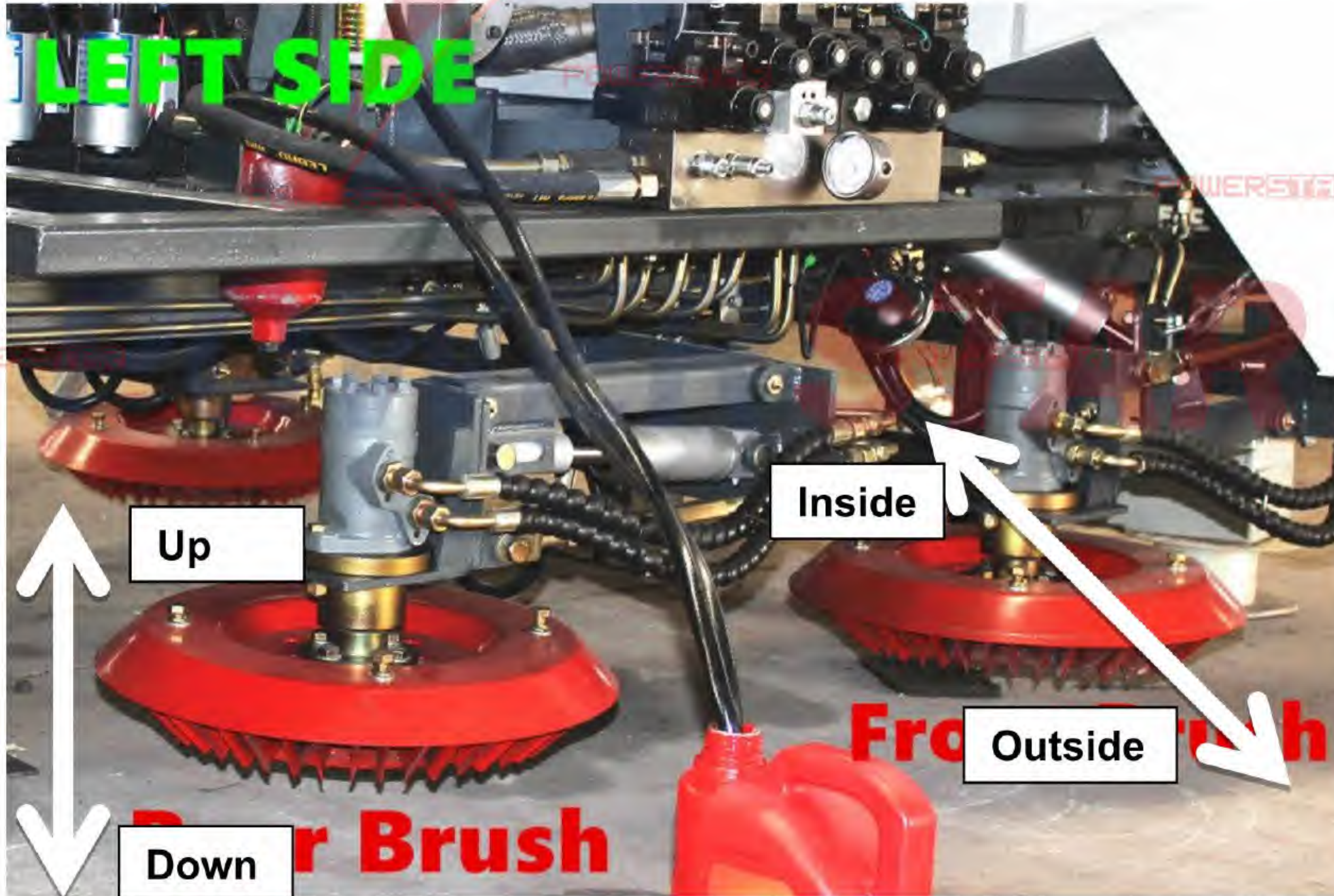

4. Button #8 (Suction) control **Suction Plate** & **Rear Brush** for left & right side.
Operation: Turn Up, the LEFT SIDE & RIGHT SIDE Rear Brushes move **up**;
the Suction Plate move **up**
Turn Down, the LEFT SIDE & RIGHT SIDE Rear Brushes move **down**.
the Suction Plate move **down**

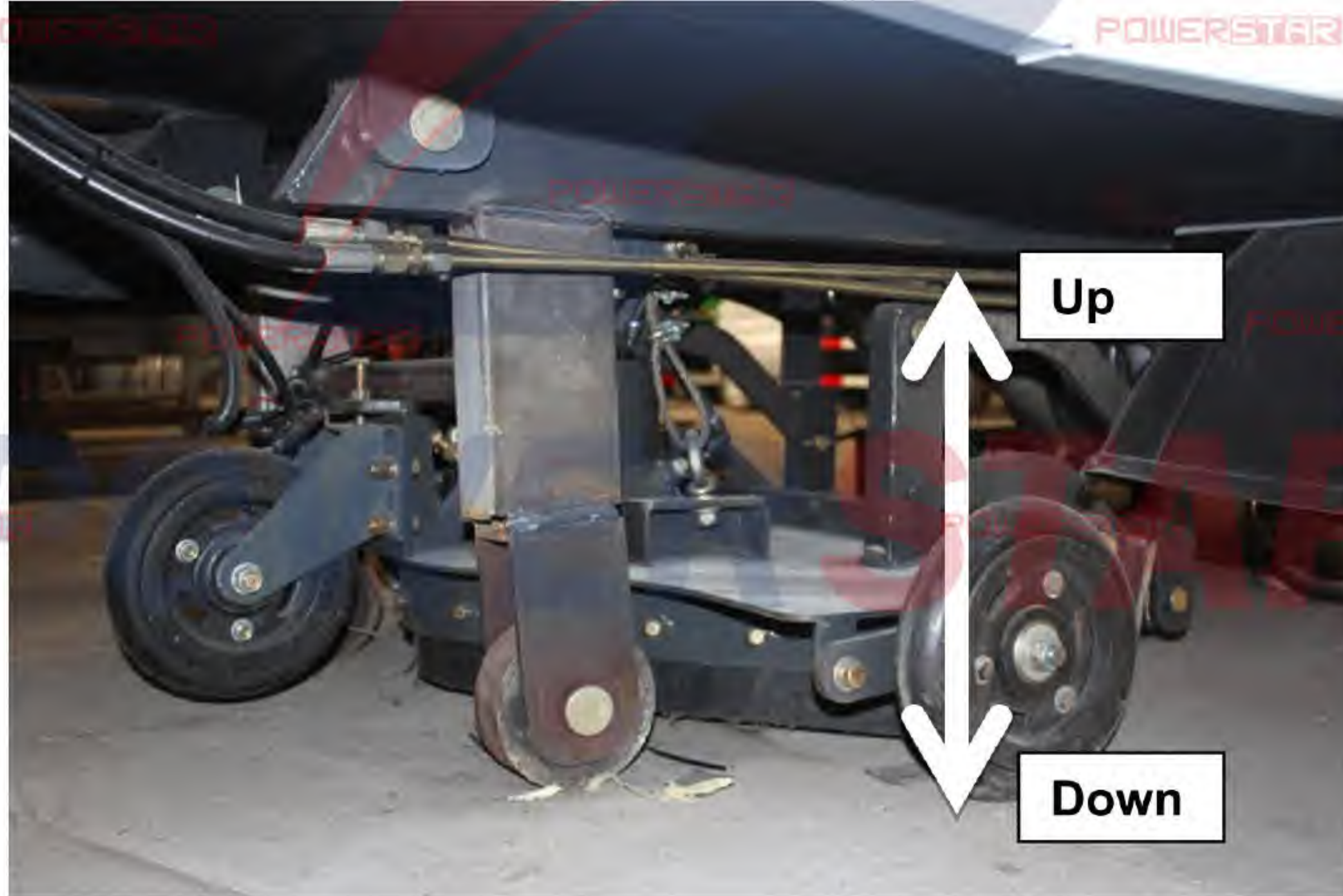

5. Button #7 (Rear door) control **Rear Door** Close & Open
Operation: Turn ON, the Rear Door **open**;
Turn OFF, the Rear Door **close**.



6. Button #6 (Dust bin) control **Garbage Box** Up & Down
Operation: Turn UP, the Dust Bin **UP**;
Turn DOWN, the Dust Bin **DOWN**.



7. Button #5 (Light) control two side **Working Light** ON & OFF
Operation: Turn ON, the Working Light **ON**;
Turn DOWN, the Working Light **OFF**.

Working Light:
Installed on auxiliary
frame above sweep plate



8. Button #4 (Water pump 3) control inter tank dust suppression **Water Pump** ON & OFF
Operation: Turn ON, the Water Pump **ON**;
Turn DOWN, the Water Pump **OFF**.

Water Spraying Nozzle:
Installed inside of dust bin



9. Button #3 (Water pump 2) control rear suction plate **Water Pump ON & OFF**
Operation: Turn ON, the Water Pump **ON**;
Turn DOWN, the Water Pump **OFF**.

Water Spraying Nozzle:
Installed on suction plate
for water spray



10. Button #2 (Water pump 1) control two sides brush plate **Water Pump ON & OFF**
Operation: Turn ON, the Water Pump **ON**;
Turn DOWN, the Water Pump **OFF**.

Water Spraying Nozzle:
Installed on brush plate
for water spray above
sweep plate



11. Button #1 (Sweeper) control **Sweeping Brush Working**
Operation: Turn ALL SWEEP, the All Sweep Brush **Working**;
Turn R.FRONT SWEEP, the Right Sweep Brush **Working**.



12. *Water Temperature Instrument Panel: When temperature is over 100 °C, please stop working.*

13. Additional Switch control **Rear Arrow Lights**



15. Control **Accelerator Handle Cable** to adjust the road sweeper truck



POWERSTAR

Chapter 7, Troubleshooting

After carefully reading the above information, you must be well known how to use the Road Sweeper Kit; below show some important parts to help solve problems.

Trouble	Analysis	Troubleshooting
Hydraulic System Leakage	<ol style="list-style-type: none"> Pipeline joint loose Seal ring or compound gasket damaged Oil tank and pipeline welding trouble 	<ol style="list-style-type: none"> Fastening pipeline joint Replace seal ring or compound gasket Cleaning and welding again
Hydraulic System Working Pressure is Lower or no Pressure	<ol style="list-style-type: none"> Overflow valve blocked or adjust lower pressure Electric system poor contact or air switch trip Hydraulic pump damaged or excessive inside drain 	<ol style="list-style-type: none"> Adjust the overflow valve and reset the pressure to 14Mpa Carefully exam all electric circuit, connect the air switch Replace hydraulic pump or sealing element
High Temperature for Hydraulic System	<ol style="list-style-type: none"> Improper setting for overflow valve Hydraulic pipeline blocked 	<ol style="list-style-type: none"> Resetting system pressure to 14Mpa Carefully exam all pipeline and eliminate blocking problem
All Hydraulic Operation invalidity	<ol style="list-style-type: none"> Electric control box disconnect, no power on hydraulic system Overflow valve does not work Hydraulic pump damage or transfer belt breakage 	<ol style="list-style-type: none"> Carefully exam whole electric circuit Checking and resetting overflow valve Replace hydraulic pump or transfer belt
Collision and no proper retract problem for garbage tank	<ol style="list-style-type: none"> Garbage tank tilting device counterbalance valve improper adjusting Overflow pressure improper 	<ol style="list-style-type: none"> Adjusting the counterbalance valve pressure, and make sure the tank drop down safety Adjust overflow pressure to 14Mpa
Sweeping plate rotating speed slowly or no working	<ol style="list-style-type: none"> Working temperature too low, hydraulic oil viscosity higher, which make higher resistance Sweeping brush gears improper Hydraulic motor or hydraulic pump damaged 	<ol style="list-style-type: none"> Replace the hydraulic oil to recommend type Mobile #46 Hydraulic Oil (compression resistance & wear resisting) Adjust to proper gear Repair the hydraulic motor or hydraulic pump
Rear Sweeper cannot drop down properly	<ol style="list-style-type: none"> Sweeping plate idle Magnetic valve blocked, and electromagnetic coil damaged Hydraulic lock blocked 	<ol style="list-style-type: none"> Turn off the sweeping plate Replace or washing magnetic valve, replace the coil Washing or replace the hydraulic lock
Rear Sweeping plate drop down and suction device raising not proper position	<ol style="list-style-type: none"> Sweeping plate and suction device hydraulic cylinder leakage Suction device wire rope too long or breakage Magnetic exchange valve or double-way lock blocked and leakage 	<ol style="list-style-type: none"> Replace the hydraulic cylinder Adjust or replace suction device wire rope Maintenance the magnetic exchange valve or double-way lock
Hydraulic oil color changed or exist air bubble	<ol style="list-style-type: none"> Hydraulic pump suffered empty absorption, and air enter into joint, pipeline or oil pimp Oil tank seals is leaking or water enter into tank during washing Hydraulic oil filter blocked and cause insufficient oil supply 	<ol style="list-style-type: none"> Carefully checking pipeline, eliminate air into problem Carefully exam the sealing for tank, replace the seal ring. Replace the hydraulic oil if necessary Cleaning or replace the filter
Sweeping plate, Suction Device or Garbage bin tilting device not work	<ol style="list-style-type: none"> Magnetic exchange valve damage or electromagnetic coil poor connection Magnetic exchange valve element does not work 	<ol style="list-style-type: none"> Carefully exam the magnetic exchange valve, replace it if necessary Push the valve element to eliminate block, cleaning it if necessary

Chapter 7, Others for Attention

After carefully reading the above information, you must be well known how to use the Road Sweeper Truck Superstructure; below show some parts you need to pay attention while using the truck.

i ,Precautions for Use

- Please strictly follow the following owner manuals:
Road Sweeper Owner's Manual
- Carefully examination the road sweeper truck:
 1. Examine all parts, especially steering device, braking device, Suspension, tires and other joints, etc.
 2. Examine Braking System, maintenance if need any help.
 3. Examine the tire pressure.
 4. Examine all lights on the truck, including Head Light, Fog Light, Turning Light, Tail Light, Arrow Light.
 5. Examine the rear Anti-Static tape, replace it if not tough the ground
- It is strictly forbidden to operate the Power Take Off (PTO) under the condition of the clutch not separation (Not step the clutch pedal). When release the clutch, you should slowly. The operation of the PTO must only on the condition of neutral for clutch.
- It is better to cleaning the dust tank and add enough water into the water tank.
- When operating all the Valves, it is not good to overexert, for overexert will influence the valve's service life.

ii ,Maintenance

- *The regular maintenance of the chassis including clutch and transmission gearbox should be properly.*
- *It should be checked all coupling and lubrication at fixed period to exclude the tight parts, and make sure all parts in good lubrication condition.*
- *When the brush wear, adjust the height of the brush plate, replace all brushes only if cannot use any more.*
- *Always add enough cooling liquid into radiator to make sure Auxiliary engine never be overheat.*
- *The strainer inside filter should be washed frequently. Exchange it if necessary.*

Whole view for Powerstar Road Sweeper Truck



